

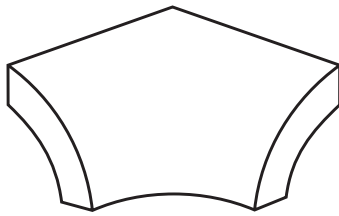

NATURAL STONE
PRODUCTS, INC.

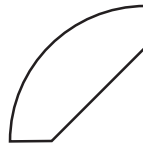

Sink Corner
99-1
2 1/2" x 2 1/2"



Quarter Round
99-2
1" x 6"

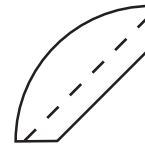

Quarter Round Laminated
99-2L
1" x 6"



Beak
99-3

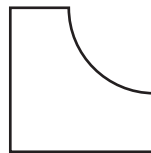

Cove Base (12")
99-4
3/4" x 3/4"

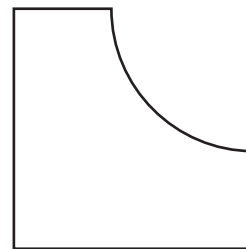

Cove Base (12")
99-4-3CM
1 1/4" x 1 1/4"

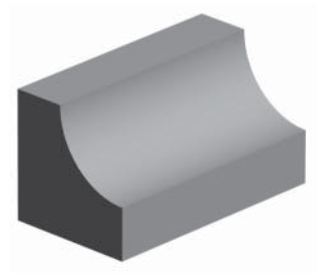

All sizes and drawings are approximate.



ROPE



100 RAINFOREST BROWN POLISHED
3/4 X 1 X 8



101 DORE ROYALE HONED
3/4 X 1-3/4 X 8



101A ROJO ALACANTE POLISHED
3/4 X 1 X 8



101B DURANGO HONED
3/4 X 1 X 12



101C JERUSALEM GOLD HONED
1-1/4 X 1-1/2 X 12



101D EMPERADOR DARK POLISHED
3/4 X 2 X 12

Stone Moldings

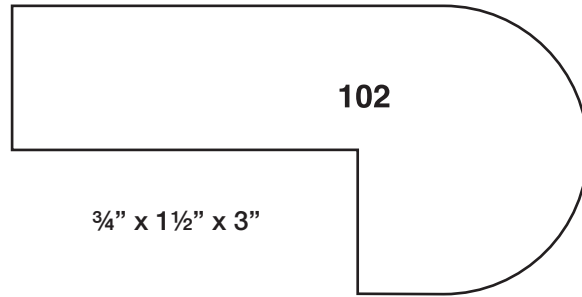

102

$\frac{3}{4}$ " x $1\frac{1}{2}$ " x 3"

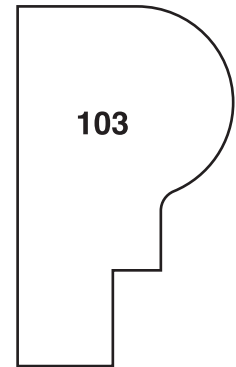

103

3 cm
 $1\frac{1}{4}$ " x 2"

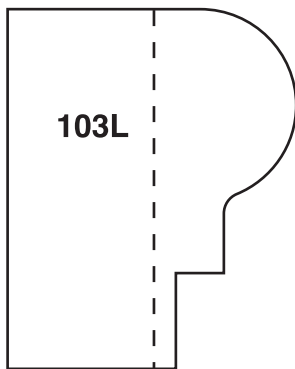

103L

$\frac{3}{4}$ " Laminated
 $1\frac{1}{2}$ " x 2"

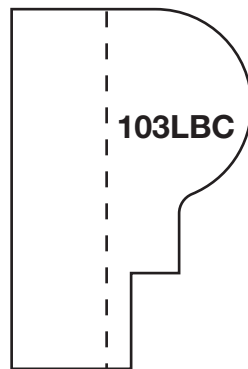

103LBC

$\frac{3}{4}$ " Laminated & Back Cut
 $1\frac{1}{4}$ " x 2"

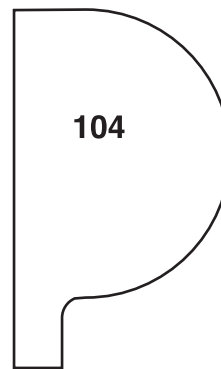

104

3 cm
 $1\frac{1}{4}$ " x 2"

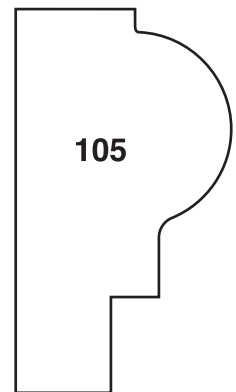

105

3 cm
 $1\frac{1}{4}$ " x 2"

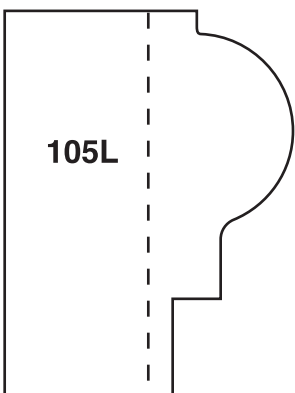

105L

$\frac{3}{4}$ " Laminated
 $1\frac{1}{2}$ " x 2"

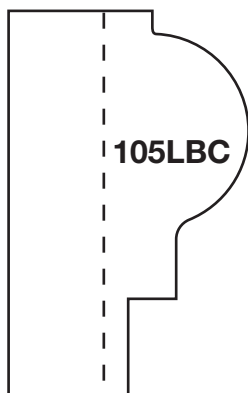

105LBC

$\frac{3}{4}$ " Laminated & Back Cut
 $1\frac{1}{4}$ " x 2"

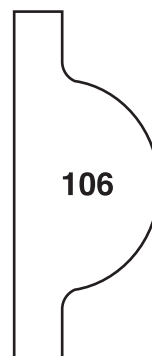

106

$\frac{3}{4}$ " x $1\frac{3}{4}$ "

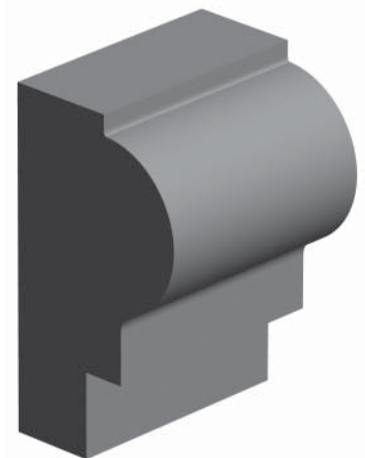

All sizes and drawings are approximate.

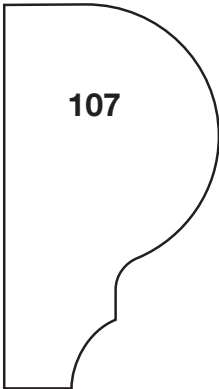

107
3 cm
1 1/4" x 2"

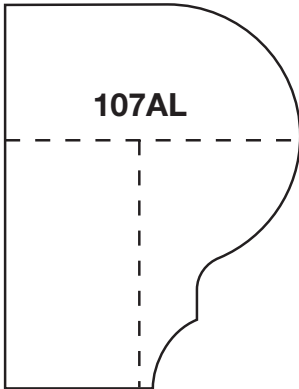

107AL
3/4" Laminated
1 1/2" x 2"

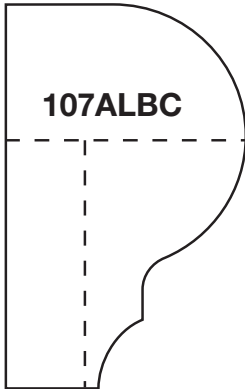

107ALBC
3/4" Laminated
& Back Cut
1 1/4" x 2"

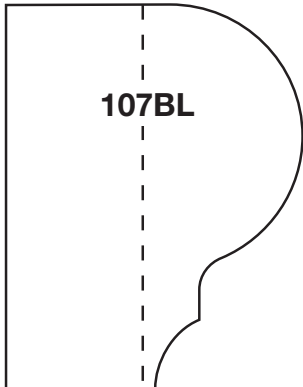

107BL
3/4" Laminated
1 1/2" x 2"

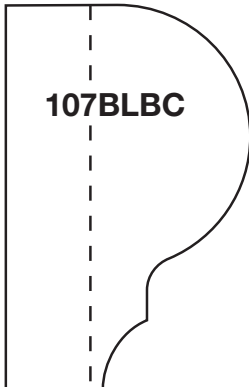

107BLBC
3/4" Laminated
& Back Cut
1 1/4" x 2"

All sizes and drawings are approximate.

Stone Moldings

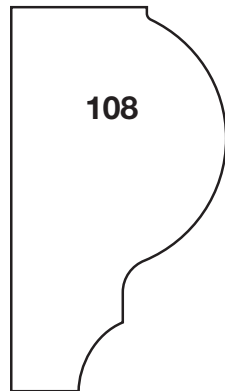

108

3 cm
1 1/4" x 2"

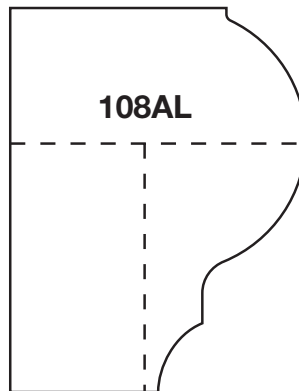

108AL

3/4" Laminated
1 1/2" x 2"

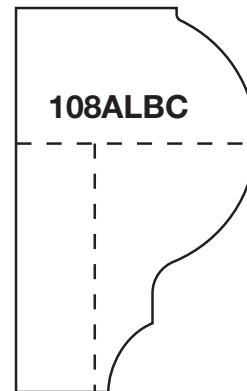

108ALBC

3/4" Laminated
& Back Cut
1 1/4" x 2"

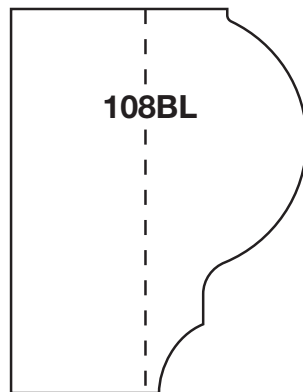

108BL

3/4" Laminated
1 1/2" x 2"

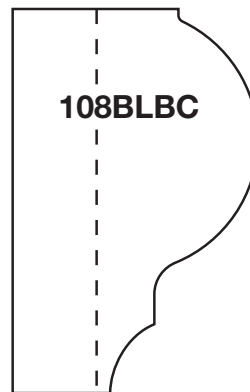

108BLBC

3/4" Laminated
& Back Cut
1 1/4" x 2"

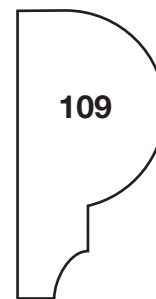

109

3/4" x 1 1/2"

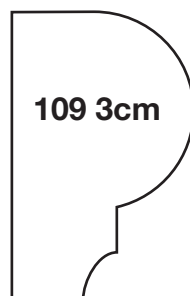

109 3cm

3 cm
1 1/4" x 1 1/2"

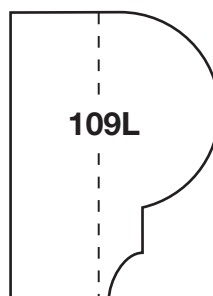

109L

3/4" Laminated
1 1/2" x 1 1/2"

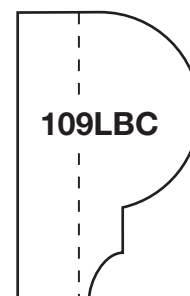

109LBC

3/4" Laminated
& Back Cut
1 1/4" x 1 1/2"

All sizes and drawings are approximate.

Stone Moldings



NATURAL STONE PRODUCTS, INC.

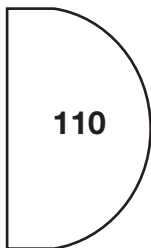

110

3/4" x 1 1/4"

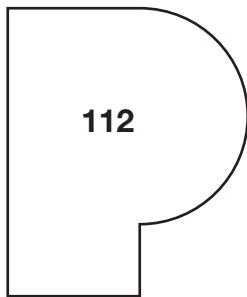

112

3 cm only
1 1/4" x 1 1/2"

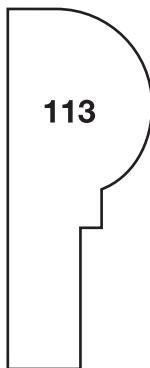

113

3/4" x 2"

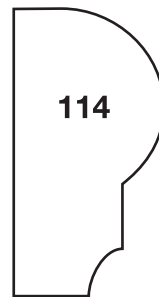

114

3/4" x 1 1/2"

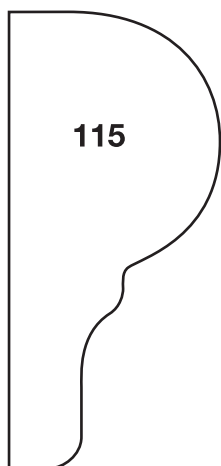

115

3 cm only
1 1/4" x 2 3/8"

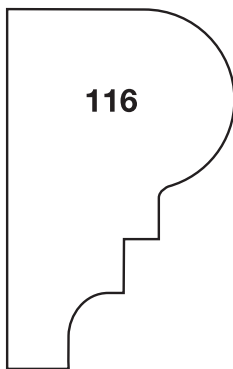

116

3 cm only
1 1/4" x 1 7/8"



117

3/4" x 2"

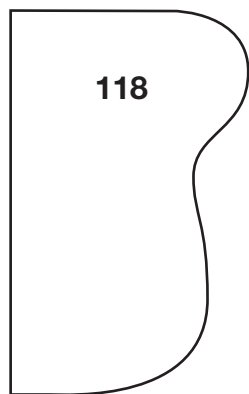

118

3 cm
1 1/8" x 2"



119

3/4" x 2 1/2"

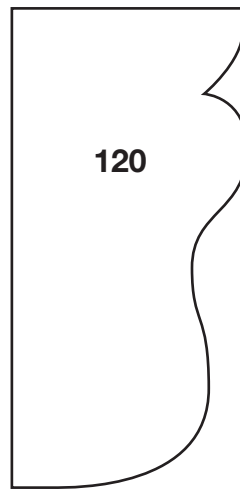

120

3 cm
1 1/8" x 2"

All sizes and drawings are approximate.

Stone Moldings

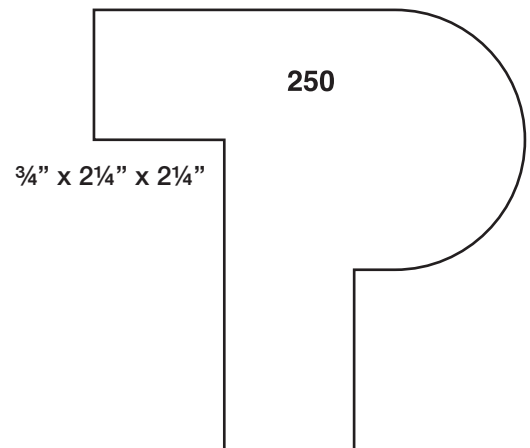
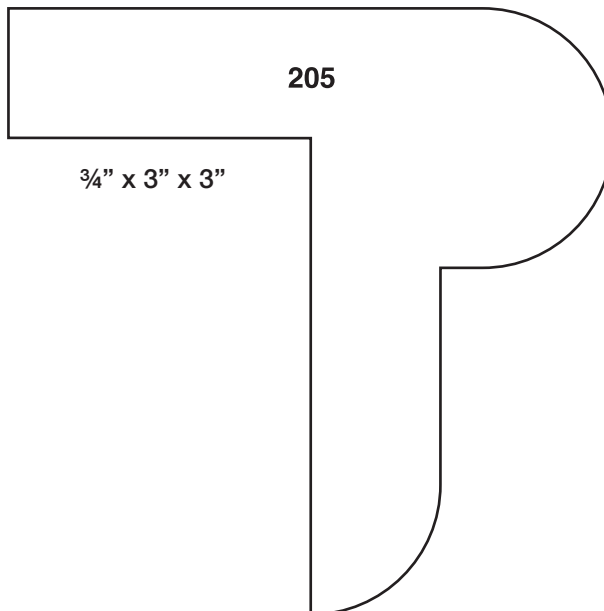
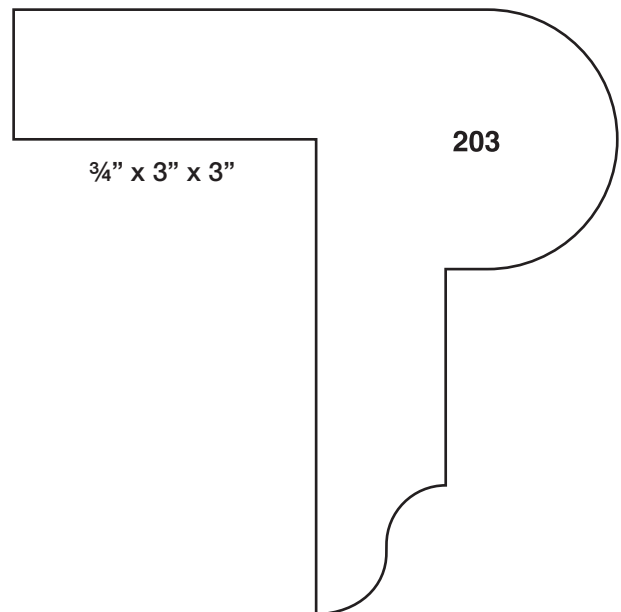
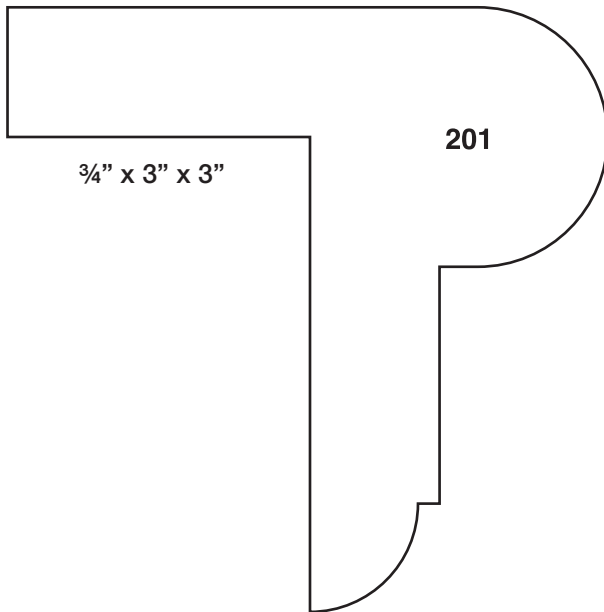

Note: Leg and skirt can be up to 12" long. Prices reflect sizes shown.

All sizes and drawings are approximate.

Stone Moldings

LM

NATURAL STONE
PRODUCTS, INC.

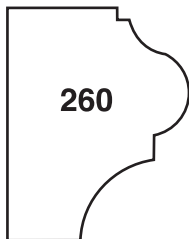

260

3 cm or 3/4" Laminated
1" x 1 1/4"

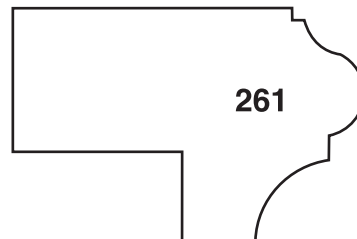

261

3 cm or 3/4" Laminated
2" x 1 1/4"

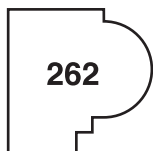

262

3/4" x 3/4"

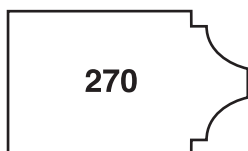

270

1 1/4" x 3/4"

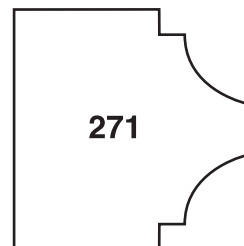

271

3 cm only
1 1/4" x 1 1/4"

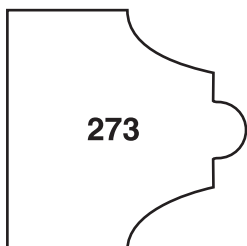

273

3 cm only
1 1/4" x 1 1/4"

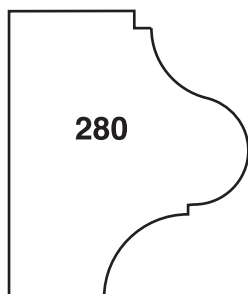

280

3 cm or 3/4" Laminated
1 1/4" x 1 1/2"

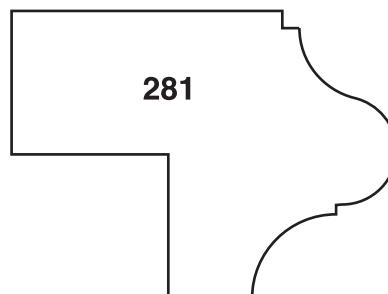

281

3 cm or 3/4" Laminated
2" x 1 1/2"

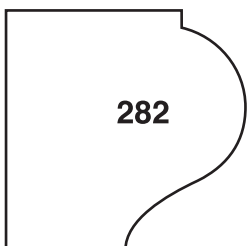

282

3 cm only
1 1/4" x 1 1/4"

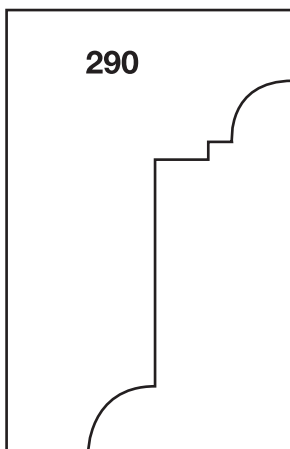

290

1 3/4" x 2 1/2"

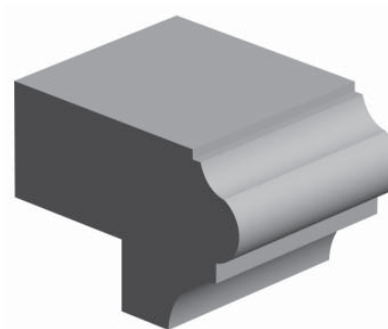

All sizes and drawings are approximate.